

Data Sheet



Article number: 20332300

Description: E+G Handwheel
GN 555-125-K14-D

Measures

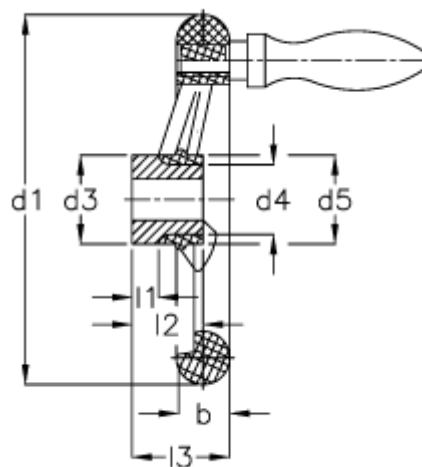
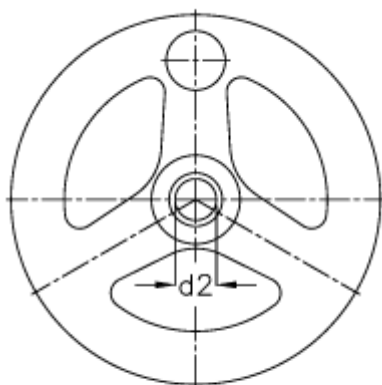

b	= 18	l1 -0.5	= 1
d1	= 125	l2 -0.5	= 25
d2 H7	= 14	l3	= 34
d2 H7	= 12	Number of spokes	= 3
d3	= 24		
d4	= 18		
d5	= 30		
Handle	= 20		